

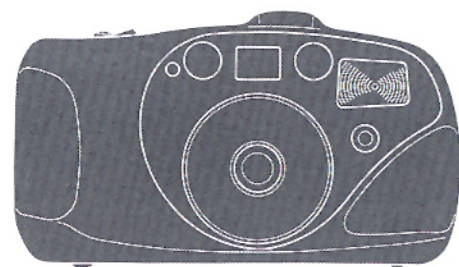

RIVA ZOOM PICO FREEDOM ACTION ZOOM AUTODATE ZOOM

INSTRUCTION MANUAL



Minolta Co., Ltd.
3-13, 2-Chome, Azuchi-Machi, Chuo-Ku, Osaka 541, Japan

Minolta GmbH
Kurt-Fischer-Strasse 60, D-22923 Ahrensburg, Germany

Minolta France S.A.
365, Route de Saint-Germain, 78420 Carrières-Sur-Seine, France

Minolta (UK) Limited
Rooksley Park, Precedent Drive, Rooksley, Milton Keynes, MK13 8HF, England

Minolta Austria Ges. m.b.H.
Amalienstrasse 59-61, 1131 Wien, Austria

Minolta Camera Benelux B.V.
Zonnebaan 39, P.O. Box 1364 3600 Maarssenbroek, The Netherlands

Belgium Branch
Koningssteenweg 38, B-2630 Aartselaar, Belgium

Minolta (Schweiz) AG
Riedstrasse 9 8953 Diellikon, Switzerland

Minolta Svenska AB
Brånkyrkagatan 84, Box 17074, S-10462 Stockholm 17, Sweden

Finland Branch
Niitykatu 6 PL 37 SF-02201 Espoo, Finland

Minolta Portugal Limitada
Av. do Brasil 33 a, 1700 Lisbon, Portugal

Head Office
101 Williams Drive, Ramsey, New Jersey 07446, U.S.A.

Los Angeles Branch
11150 Hope Street Cypress, CA 90630, U.S.A.

Head Office
369 Britannia Road East, Mississauga, Ontario L4Z 2H5, Canada

Vancouver Branch
106-3850 Jacombs Road, Richmond, B.C. V6V 1Y6, Canada

Minolta Hong Kong Limited
Room 208, 2/F, Eastern Center, 1065 King's Road, Quarry Bay, Hong Kong

Minolta Singapore (Pte) Ltd.
10, Tebon Gardens Crescent, Singapore 2260



© 1993 Minolta Co., Ltd. under the Berne Convention and Universal Copyright Convention

P9407-D407
9222-2404-11
Printed in Japan

Congratulations on your purchase of this zoom-compact camera. This manual provides you with short explanations for each function, plus all the information you'll need to understand and operate this camera properly. To begin taking pictures in the easiest way possible, read **Getting Started**. Later, when you're ready to learn how to use the camera's other buttons and functions and improve your pictures, move along to **Advanced Operation**.

NAMES OF PARTS

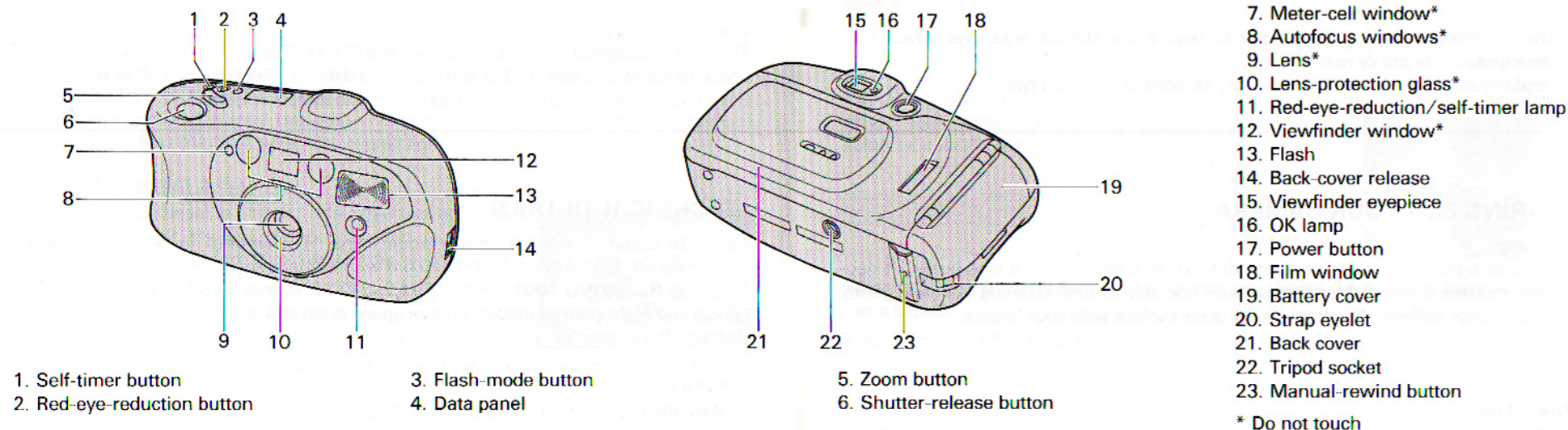

VIEWFINDER

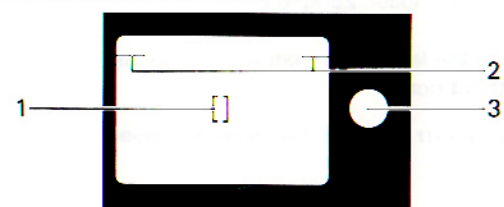

- 1. Focus frame**
Camera focuses within this frame.
- 2. Close-framing guides**
When camera-to-subject distances are less than 1m, the picture should be composed within this frame.
- 3. OK lamp:**
Glowing: Focus is locked and flash charged.
Blinking: Subject is too close.
Blinks once: Flash charging is complete.

DATA PANEL

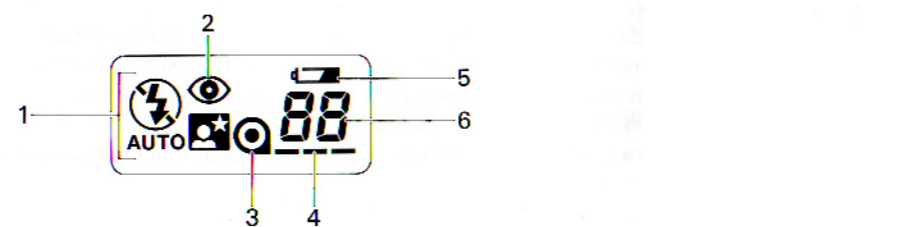

- 1. Flash-mode indicator**
⚡ : Auto-switchover flash
⚡ : Manual fill-flash
⚡ : Flash cancel
⚡ : Night-portrait flash
- 2. Red-eye-reduction indicator**
- 3. Film-cartridge mark**
- 4. Film-transport signals**
- 5. Low-battery symbol**
- 6. Frame counter**

INSERTING THE BATTERY

Your camera uses a 3-volt lithium battery (CR123A/DL123A) that supplies power for all camera operations.

- Battery Cautions**
- Read and follow all warnings and instructions supplied by the battery manufacturer.
 - Keep batteries away from children.
 - Do not attempt to disassemble, recharge or short out the battery, or subject it to high temperatures or fire.

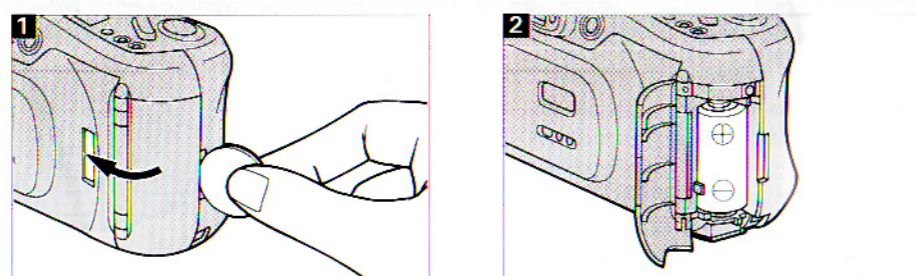

- 1** Use a coin to open the battery cover.
- 2** Insert the battery as shown on the inside of the battery chamber and snap the cover closed.

LOW-BATTERY SYMBOL

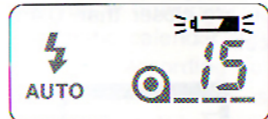

If the blinking low-battery symbol appears in the data panel with the other indicators, you can still use the camera, but the battery will have to be replaced soon.

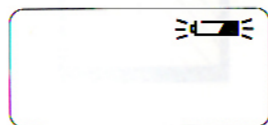

If the blinking low-battery symbol appears alone, you cannot use the camera until you replace the battery.

AUTO POWER OFF

To save power, your camera automatically turns itself off if not operated for more than three minutes.

LOADING THE FILM

You should only use DX-coded, 35mm film with ISO ratings 25 to 3200.

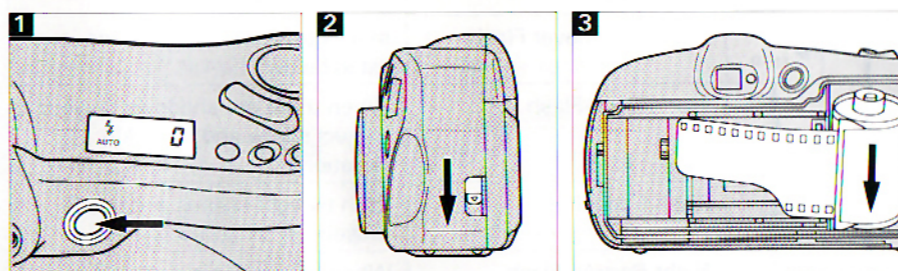

- 1** Turn on the camera and make sure 0 is displayed in the data panel.
- 2** Open the back cover by sliding down the back-cover release.
- 3** Place the film cartridge, bottom first, into the film chamber as shown. Always load your film in the shade or at least away from direct sunlight.

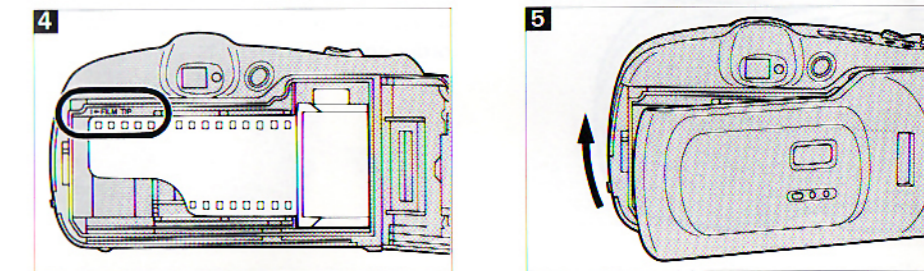

- 4** Lay the film flat between the guide rails and extend the film to the "FILM TIP" mark. If the film extends too far, gently push the excess back into the cartridge.
- 5** Snap the back cover closed. The film automatically advances to the first frame and 1 appears in the data panel.



If 0 blinks in the data panel, the film was incorrectly loaded. Open the back cover and re-load the film.

BASIC OPERATION

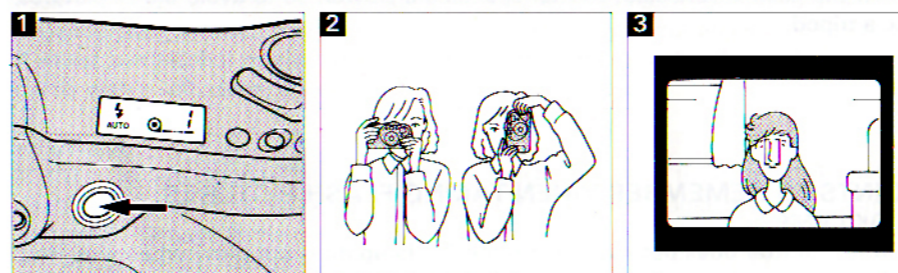

- 1** Press the power button to turn on the camera.
- 2** Hold the camera steady and make sure your fingers are not covering the flash. If you are taking a vertically-framed picture, keep the flash on top.
- 3** Center the focus frame on your subject.

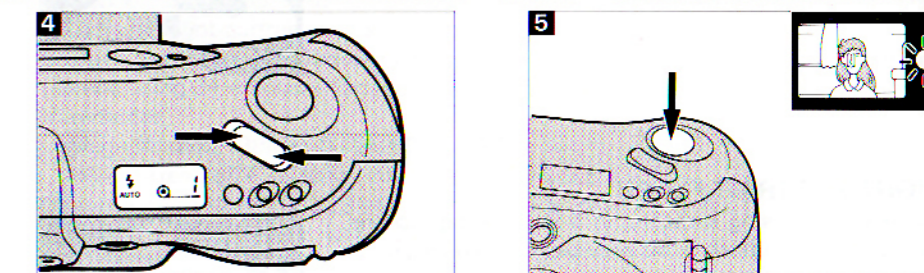
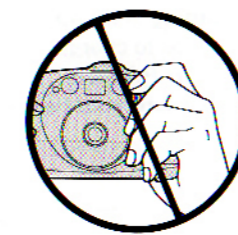

- 4** Zoom the lens by pressing the right side of the zoom button to move towards telephoto and the left side for wide.
- 5** Press the shutter-release button partway down so that the OK lamp glows and then all-the-way down to take the picture. Always press the shutter-release button with a slow, steady squeeze—never a quick jab. The film automatically advances to the next frame.

FILM REWIND

AUTOMATIC REWIND

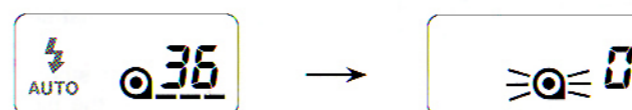

After you take the last picture on the roll of film, the camera automatically begins rewind and the frame counter counts down to 0. When 0 appears in the data panel and the film-cartridge mark blinks, open the back cover and remove the film.

CAUTION

If 0 doesn't appear in the data panel after the motor stops running, check the battery level, you may have to change the battery.

MANUAL REWIND

If you don't want to take the whole roll of pictures, you can begin film-rewind manually.

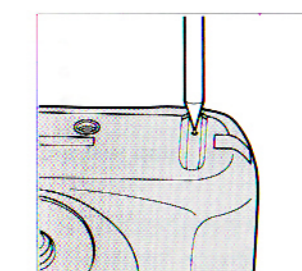

1. Press the manual-film-rewind button using a pen or similar object. Manual rewind does not operate when the camera is turned off.
2. When 0 and the blinking film-cartridge mark appear in the data panel, open the back and take out the film.

FOCUS HOLD

Hold focus on the subjects that you do not want in the center of the picture.

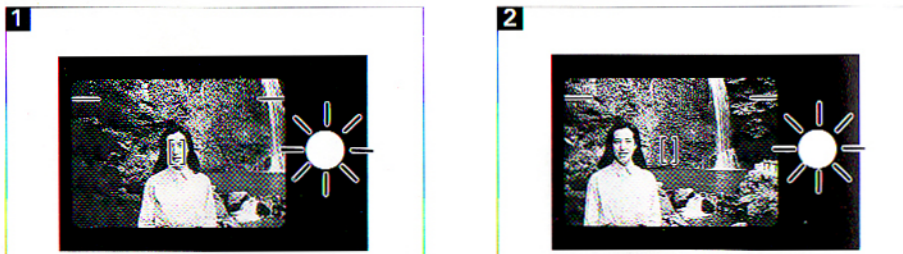

- Center the focus frame on your subject, then press and hold the shutter-release button partway down so the OK lamp glows. If your subject is behind glass, use focus hold on something of equal distance from the camera.
- Without lifting your finger, recompose the frame and press the shutter-release button all-the-way down to take the picture.

TAKING CLOSE-UP PICTURES

Make sure that you are at least 0.60m (2.0ft.) from your subject. The OK lamp blinks when you are too close to the subject, however, if you are closer than 0.4m (1.3ft.), the OK lamp will glow, but the picture will not be in focus.

When your subject is closer than 1m (3.3ft.), compose the picture within the close-framing guides.

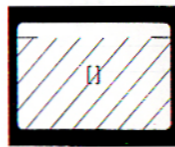

FLASH

FLASH-MODE BUTTON

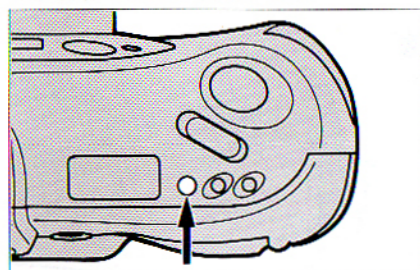

Pressing the flash-mode button successively changes the flash modes in the order shown.

Flash Mode	When to Use
Auto-Switchover Flash	In all situations, except those listed below
Manual Fill-Flash	When there are shadows on your subject's face and in backlit situations
Flash Cancel	With twilight scenes and inside museums
Night-Portrait Flash	When your subject is placed in front of a night scene

The indicator of the flash mode selected appears in the data panel. The flash modes remain selected after you take the picture. To cancel, change the flash mode or turn off the camera.

AUTO-SWITCHOVER FLASH

When the camera is turned on, auto-switchover flash is initially set. The camera automatically fires the flash when the overall light level is low.

MANUAL FILL-FLASH

Use manual fill-flash to "fill-in" the shadows on your subject's face. It should also be selected in backlit situations. The flash will fire every time you take a picture.



NIGHT-PORTRAIT FLASH

When you're posing someone in front of a night scene, use night-portrait flash. This provides balanced exposure between your subject and the background.



In this mode, shutter speeds are slow; please use a tripod and warn your subjects to remain still.

FLASH CANCEL

When you're photographing twilight scenes or distant subjects, cancel the flash.



When the flash is canceled, shutter speeds are slower, so to avoid blurry pictures, use a tripod.

POINTS TO REMEMBER WHEN TAKING FLASH PICTURES:

- OK LAMP**
If the shutter does not release and the OK lamp does not glow when you press the shutter-release button all-the-way down, the flash is charging. When flash charging is complete, the OK lamp blinks once. The flash takes approximately 6 seconds to charge.
- FLASH RANGE**
Make sure your camera-to-subject distance is within the flash range.

	Flash Range	
	ISO 100	ISO 400
38mm	0.6m to 4.2m (2.0ft. to 13.8ft.)	0.6m to 8.4m (2.0ft. to 27.6ft.)
60mm	0.6m to 2.8m (2.0ft. to 9.2ft.)	0.6m to 5.6m (2.0ft. to 18.4ft.)

SELF-TIMER PHOTOGRAPHY

You can include yourself in the picture by selecting self-timer.

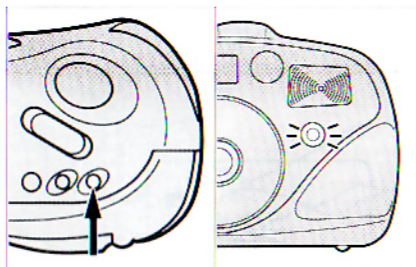



- Set up the picture.
- Press the self-timer button; the picture is taken 10 seconds later. The OK lamp glows and the self-timer lamp on front of the camera blinks to show that self-timer is operating. If you want to stop self-timer operation before the picture is taken, turn off the camera.

To use focus hold with self timer, press the self-timer button and quickly recompose the picture before the shutter release.

RED-EYE REDUCTION

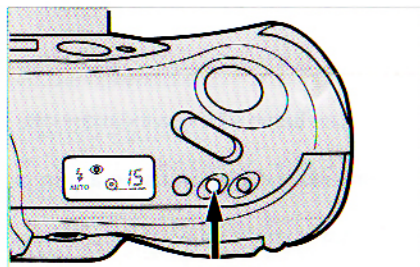
Avoid red-eye in flash pictures of people by using red-eye reduction!



Press the red-eye-reduction button so that  appears in the data panel.

Warn the people you are photographing that the red-eye-reduction lamp will fire three bursts before the picture is taken.

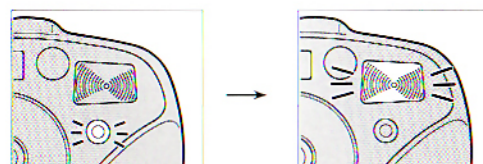

When you press the shutter-release button all-the-way down, first, the red-eye-reduction lamp fires, then the main flash fires with the shutter release.

FOR OWNERS OF THE QUARTZ DATA BACK MODEL

The data back enables you to record the date, in a choice of three year/month/day formats, or time (day/hour/minute) directly onto the film. It features a quartz clock and automatic calendar through the year 2019, and automatically controls the imprint exposure according to the camera's film-speed setting. With the camera held horizontally, the data is recorded onto the lower right portion of the picture; in the vertical format, imprinting occurs on the lower left portion of the picture.



Names of Parts

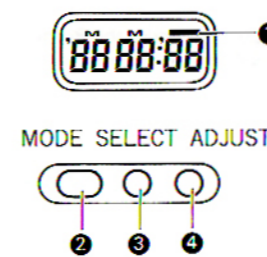

- Print indicator
- MODE button
- SELECT button
- ADJUST button

Mode Selection

Use the MODE button to change the data display as shown.

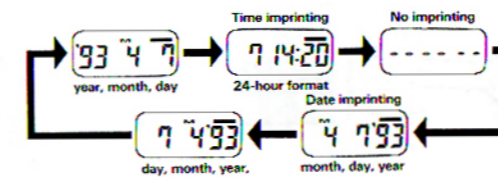

Data Imprinting

Press the MODE button to select the desired data type, then take the picture. Following exposure, the print indicator blinks in the data panel for approximately two seconds to confirm imprinting.

- The imprinted data may be difficult to read if the subject area over which it is superimposed is bright or non-uniform.
- Legibility of the imprinted data may vary somewhat with film type.

CARING FOR YOUR CAMERA

Cleaning

- If the lens-protection glass becomes dirty, clean it gently with a lens brush. If necessary, moisten a sheet of lens tissue with one drop of lens-cleaning fluid and gently wipe the glass surface. Never touch the glass surface with your fingers.
- Never use alcohol or chemical solvents on the camera body. If it is dirty, wipe it gently with a soft, clean, dry cloth.

Precautions

- Use extra care when taking pictures at the beach. Do not let the camera get wet and do not let sand or other grit get into the camera. This could result in costly or irreparable damage to the camera.
- This camera is designed for use between -10 and 40°C (14 to 104°F).
- Never subject the camera to shock, high heat, or humidity.
- Using the camera at very low temperatures impairs its performance. In cold weather, carry the camera inside your coat to keep it warm. Do not transfer the camera directly from an extremely cold to warm area, since condensation may form inside and prevent normal operation.
- This camera contains high-voltage circuits. Do not attempt to disassemble or repair it yourself.

Storage

- When not in use, keep the camera in a cool, dry place away from dust and chemicals. For extended storage we recommend that you place the camera in an airtight container with a drying agent such as silica gel.
- Do not store your camera in the glove compartment or other places in motor vehicles where it may be subjected to high temperatures.

Questions and Service

- If you have questions about your camera, contact your local camera dealer. For more information write to the Minolta distributor or subsidiary in your area (addresses listed at the back of this manual).
- To assure prompt service, please contact an authorized Minolta Service Center before shipping your camera for repairs.

Setting Data

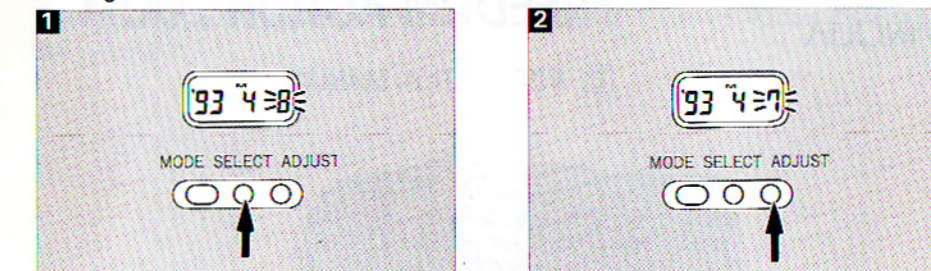

- Use the SELECT button to move between different parts of the displayed data. With the date displayed, pressing the SELECT button in succession causes the settings for year, month, and then day to blink. In time mode, pressing the SELECT button successively causes the hour, minute, and then the colon to blink.
- Press the ADJUST button to change the blinking display. In time mode, pressing the ADJUST button while the colon is blinking synchronizes the seconds counter to 00.

Battery Replacement

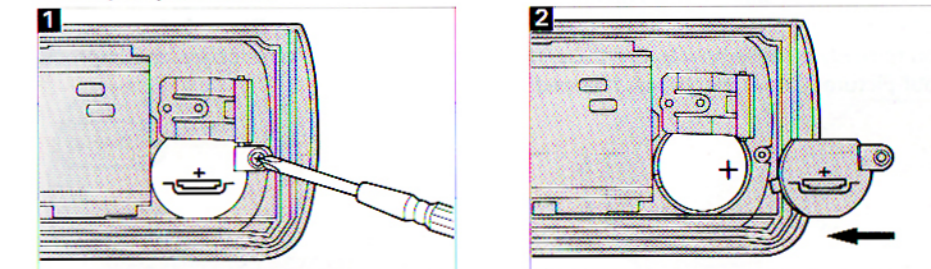

- Open the camera back. Remove the screw from the battery cover using a small Phillips screwdriver.
- Insert the new battery (+ side up). Replace the battery cover and attach with the screw. Following battery replacement, reset day and time.

Care and Storage

This unit is designed for use between 40 and 0°C (104 and 32°F). At temperatures above or below this range, LCD and imprinted date may become difficult to read. Even higher temperatures may cause the LCD to temporarily blacken.

TECHNICAL DETAILS

Lens: 38-60mm f/4.3-6.4 power zoom lens; 4 elements in 4 groups; max. magnification: 1/10X (for subjects at 0.6m with 60mm lens)
Metering Range (ISO 100): 38mm: EV4.2 to EV15; 60mm: EV5.4 to EV16.2; in flash-cancel and night-portrait modes, shutter speed is set to 1 sec.
Battery Performance: Approximately 15 rolls (based on Minolta's standard test method using 24 exposure film with flash 50% of exposures)
Viewfinder
Magnification: 38mm: 0.45x; 60mm: 0.65x
Image Area: 85% coverage (for subject at 3m/9.8 ft.)
Dimensions: 132.5(W) x 70.5(H) x 43.5mm(D)* (5-3/16 x 2-3/4 x 1-11/16 in.)
 *QD model: 48mm (D) (1-7/8 in.)
Weight (without battery): 240g (8.5oz)
 QD model: 250g (8.8oz)

Specifications are based on the latest information available at the time of printing and are subject to change without notice.

STATEMENT OF FCC COMPLIANCE

This device complies with Part 15 of the FCC Rules. Operation is subject to the following two conditions: (1) This device may not cause harmful interference, and (2) this device must accept any interference received, including interference that may cause undesired operation. Changes or modifications not approved by the party responsible for compliance could void the user's authority to operate the equipment. This equipment has been tested and found to comply with the limits for a Class B digital device, pursuant to Part 15 of the FCC Rules. These limits are designed to provide reasonable protection against harmful interference in a residential installation. This equipment generates, uses and can radiate radio frequency energy and, if not installed and used in accordance with the instructions, may cause harmful interference to radio communications. However, there is no guarantee that interference will not occur in a particular installation. If this equipment does cause harmful interference to radio or television reception, which can be determined by turning the equipment off and on, the user is encouraged to try to correct the interference by one or more of the following measures:

- Reorient or relocate the receiving antenna.
- Increase the separation between the equipment and receiver.
- Connect the equipment into an outlet on a circuit different from that to which the receiver is connected.
- Consult the dealer or an experienced radio/TV technician for help.

STATEMENT OF DOC COMPLIANCE

This digital apparatus does not exceed the Class B limits for radio noise emissions from digital apparatus as set out in the Radio Interference Regulations of the Canadian Department of Communications.